

DOMINO SUSPENSION

D81045-WHI

GENERAL

Series: Domino
 Brand: Panzeri
 Division: Design
 Mounting Type: Suspension
 Mounting Location: Ceiling
 Subcategory: Pendant

PHYSICAL

Length (mm): 110
 Length (in): 4 ⁵/₁₆
 Width (mm): 80
 Width (in): 3 ¹/₈
 Height (mm): 260
 Height (in): 10 ¹/₄
 Max. Overall Height (mm): 2260
 Max. Overall Height (in): 89
 Weight (kg): 1.23
 Weight (lbs): 2.71
 Diffuser: Matte White Blown Glass

ELECTRICAL

Number of Lamps: 1
 Lamp Type: LED Retrofit / Halogen
 Bulb Included: Bulb Not Included
 Total Output Wattage (W): 13 / 60
 Max. Wattage Per Lamp (W): 13 / 60
 Lamp Base: G9
 Input Voltage (V): 120

LED

OPTICAL

RATINGS AND CERTIFICATIONS

Certified By: CSA Certified to UL and CSA Standards

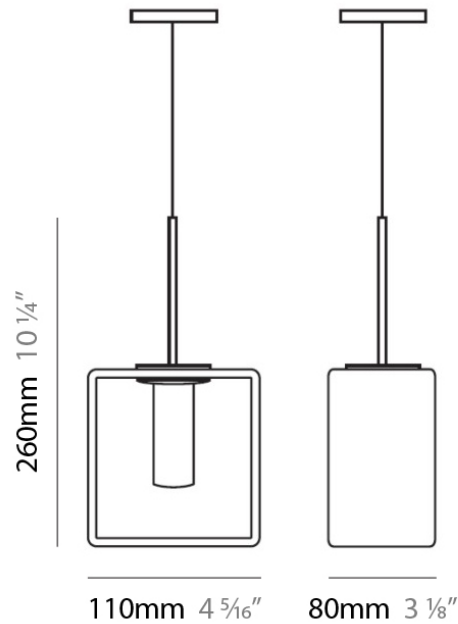

DOMINO SUSPENSION

D81048-BLK

PROJECT _____

TYPE _____

NOTES _____

QUANTITY _____

DATE _____

GENERAL

Series: Domino

Brand: Panzeri

Division: Design

Mounting Type: Suspension

Mounting Location: Ceiling

Subcategory: Pendant

PHYSICAL

Length (mm): 140

Length (in): 5 1/2

Width (mm): 90

Width (in): 3 9/16

Height (mm): 290

Height (in): 11 7/16

Max. Overall Height (mm): 2290

Max. Overall Height (in): 90 3/16

Weight (kg): 1.23

Weight (lbs): 2.71

Diffuser: Black Blown Glass

ELECTRICAL

Number of Lamps: 1

Lamp Type: LED Retrofit / Halogen

Bulb Included: Bulb Not Included

Total Output Wattage (W): 13 / 60

Max. Wattage Per Lamp (W): 13 / 60

Lamp Base: G9

LED

OPTICAL

RATINGS AND CERTIFICATIONS

Certified By: CSA Certified to UL and CSA Standards

IP rating: IP20

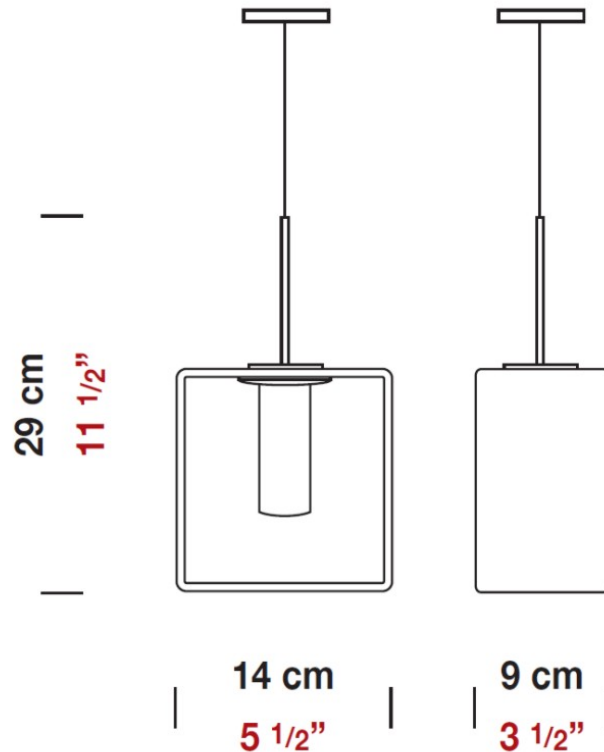

DOMINO SURFACE

D82033-BLK

PROJECT _____

TYPE _____

NOTES _____

QUANTITY _____

DATE _____

GENERAL

Series: Domino

Brand: Panzeri

Division: Design

Mounting Type: Surface

Mounting Location: Ceiling

Subcategory: Ambient

PHYSICAL

Shape: Rectangle

Length (mm): 110

Length (in): 4 ⁵/₁₆"

Width (mm): 80

Width (in): 3 ¹/₈"

Height (mm): 130

Height (in): 5 ¹/₈"

Extension (in): 5 ¹/₈"

Weight (kg): 1.23

Weight (lbs): 2.7

Diffuser: Black Blown Glass

Fixture Material: Glass / Aluminum

ELECTRICAL

Number of Lamps: 1

Lamp Type: LED Retrofit / Halogen

Bulb Included: Bulb Not Included

Total Output Wattage (W): 3 / 35

Max. Wattage Per Lamp (W): 3 / 35

Lamp Base: G9

Input Voltage (V): 120

LED

OPTICAL

RATINGS AND CERTIFICATIONS

Certified By: CSA Certified to UL and CSA Standards

IP rating: IP40

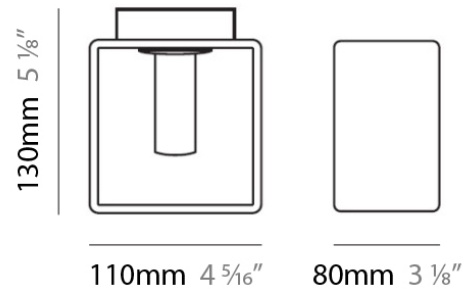

DOMINO SURFACE

D82033-WHI

PROJECT _____

TYPE _____

NOTES _____

QUANTITY _____

DATE _____

GENERAL

Series: Domino

Brand: Panzeri

Division: Design

Mounting Type: Surface

Mounting Location: Ceiling

Subcategory: Ambient

PHYSICAL

Shape: Rectangle

Length (mm): 110

Length (in): 4 ⁵/₁₆"

Width (mm): 80

Width (in): 3 ¹/₈"

Height (mm): 130

Height (in): 5 ¹/₈"

Extension (in): 5 ¹/₈"

Light Distribution: Direct / Indirect

Weight (kg): 1.23

Weight (lbs): 2.71

Diffuser: Matte White Blown Glass

Fixture Material: Glass / Aluminum

ELECTRICAL

Number of Lamps: 1

Lamp Type: LED Retrofit / Halogen

Lamp Shape: T4

Bulb Included: Bulb Not Included

Total Output Wattage (W): 13 / 60

Max. Wattage Per Lamp (W): 13 / 60

Lamp Base: G9

Input Voltage (V): 120

LED

OPTICAL

RATINGS AND CERTIFICATIONS

Certified By: CSA Certified to UL and CSA Standards

IP rating: IP20

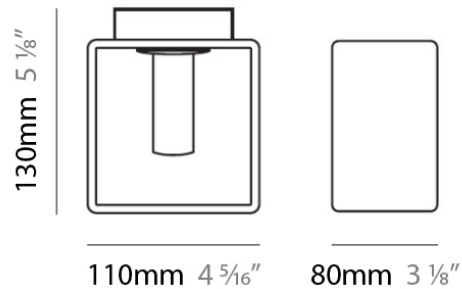

DOMINO SURFACE

D82074

PROJECT	_____
TYPE	_____
NOTES	_____
QUANTITY	_____
DATE	_____

GENERAL

Series: Domino
Brand: Panzeri
Division: Design
Mounting Type: Surface
Mounting Location: Ceiling

PHYSICAL

Shape: Cube
Length (mm): 230
Length (in): 9
Width (mm): 230
Width (in): 9
Height (mm): 160
Height (in): 6 5/16
Light Distribution: Direct
Weight (kg): 1.8
Weight (lbs): 4
Diffuser: Frosted White Glass
Fixture Material: Stainless Steel

ELECTRICAL

Number of Lamps: 2
Lamp Type: LED Retrofit
Lamp Shape: T4
Bulb Included: Bulb Not Included
Total Output Wattage (W): 6
Max. Wattage Per Lamp (W): 3
Lamp Base: G9
Input Voltage (V): 120

LED

OPTICAL

RATINGS AND CERTIFICATIONS

Certified By: CSA Certified to UL and CSA Standards
IP rating: IP40

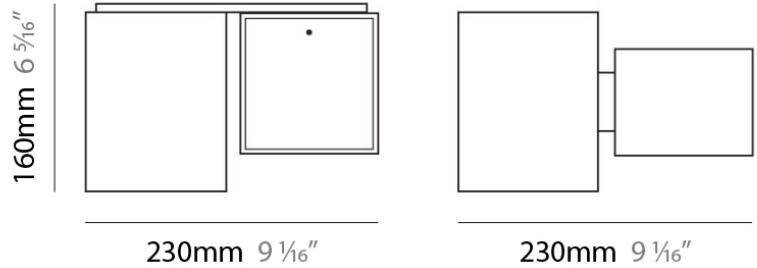

DOMINO SURFACE

D82075

PROJECT	_____
TYPE	_____
NOTES	_____
QUANTITY	_____
DATE	_____

GENERAL

Series: Domino
Brand: Panzeri
Division: Design
Mounting Type: Surface
Mounting Location: Ceiling
Subcategory: Ambient

PHYSICAL

Shape: Rectangle
Length (mm): 330
Length (in): 13
Width (mm): 90
Width (in): 3 1/2
Height (mm): 130
Height (in): 5 1/8
Light Distribution: Downlight
Weight (kg): 2.3
Weight (lbs): 5
Diffuser: Frosted White Glass
Fixture Material: Stainless Steel

ELECTRICAL

Number of Lamps: 3
Lamp Type: LED Retrofit / Halogen
Lamp Shape: T4
Bulb Included: Bulb Not Included
Total Output Wattage (W): 21 / 105
Max. Wattage Per Lamp (W): 7 / 35
Lamp Base: G9
Input Voltage (V): 120

LED







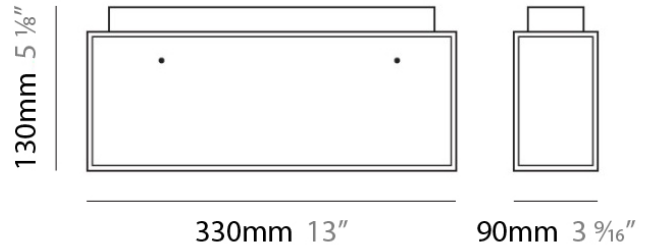





























































OPTICAL

RATINGS AND CERTIFICATIONS











Certified By: CSA Certified to UL and CSA Standards
IP rating: IP40













LEGEND

	floor-mounted		pivotal		special LED (upon request) RGB, RGBW, tunable, gold+, meat+, art+, fashion+
	wall and ceiling: recessed and surface mounted		rotating		warm dim / natural dimming LED
	ceiling-mounted and wall-mounted		illuminate tilted		rechargeable battery powered
	wall-mounted		color of suspension cable		fixture with natural vivid LED (upon request)
	omni-directional light distribution		length of suspension cable		color rendering index
	direct light distribution		reflector degree selection		color temperature
	direct/indirect light distribution		super spot		lumen (luminous flux)
	indirect light distribution		lens		efficacy (lumens per watt)
	asymmetric light distribution		lens pack		Unified Glare Rating (UGR) range from 5-40
	aura light distribution		shine ring		marine grade (AISI 316 stainless steel)
	round wall or ceiling cut-out		integrated shine ring with diffuser		walk on
	square wall or ceiling cut-out		free individual colors 01-29		drive on
	the supplied jig specifies the cutout dimensions		individual colors: 00 (free of charge), 01-25 (extra charge)		Dark Sky Compliance
	minimum distance (meters) lamp - object		luminaire part to be colored (F1)		Americans with Disabilities Act (less than 4" off the wall located between 27"-84" from floor)
	recessed depth		luminaire part to be colored (F2)		lamp protected against explosion
	ceiling thickness in mm		luminaire part to be colored (F3)		blown glass using traditional methods by master glass blower
	ceiling thickness selection		luminaire part to be colored (F4)		acoustic material
	dimmable DP (phase), DV (0-10V), DD (dali), DS (step-dim)		luminaire part to be colored (F5)		protection class I, protection insulation
	included or excluded LED driver/transformer/control gear		color of 3-circuit adaptor		protection class II, protection insulation
	separately switchable		indirect diffuser		ETL Certified to UL and CSA Standards
	sensor		direct diffuser		UL Certified to UL and CSA Standards
	remote control		ball-proof (upon request)		CSA Certified to UL and CSA Standards
	available upon request		accessory		Certified for North American Standards

IP RATING

	protected against ingress of solid bodies greater than 12.5mm (finger)
	protected against ingress of solid bodies greater than 2.5mm protected against sprays of water up to 60 degrees from the vertical (rain)
	protected against ingress of solid bodies greater than 1mm (wire) no protection against the ingress of moisture
	protected against ingress of solid bodies greater than 1mm (wire) protected against sprays of water up to 60 degrees from the vertical (rain)
	protected against ingress of solid bodies greater than 1mm (wire) protected against water splashed from all directions
	protected against limited ingress of dust (wet rooms/covered outdoor areas) protected against water splashed from all directions
	protected against ingress of dust protected against jets of water
	protected against ingress of dust protected against powerful jets of water or heavy seas
	protected against ingress of dust protected against immersion of water between 15cm - 1m for 30 minutes
	protected against ingress of dust protected against immersion of water under pressure for long periods

IK RATING

	protected against 0.14 joules impact (equivalent to 0.25kg mass dropped from 56mm above the surface)
	protected against 0.2 joules impact (equivalent to 0.25kg mass dropped from 80mm above the surface)
	protected against 0.35 joules impact (equivalent to 0.25kg mass dropped from 140mm above the surface)
	protected against 0.5 joules impact (equivalent to 0.25kg mass dropped from 200mm above the surface)
	protected against 0.7 joules impact (equivalent to 0.25kg mass dropped from 280mm above the surface)
	protected against 1 joules impact (equivalent to 0.25kg mass dropped from 400mm above the surface)
	protected against 2 joules impact (equivalent to 0.5kg mass dropped from 400mm above the surface)
	protected against 5 joules impact (equivalent to 1.7kg mass dropped from 300mm above the surface)
	protected against 10 joules impact (equivalent to 5.0kg mass dropped from 200mm above the surface)
	protected against 20 joules impact (equivalent to 5.0kg mass dropped from 400mm above the surface)